

## Six-piece interlocking puzzle plan

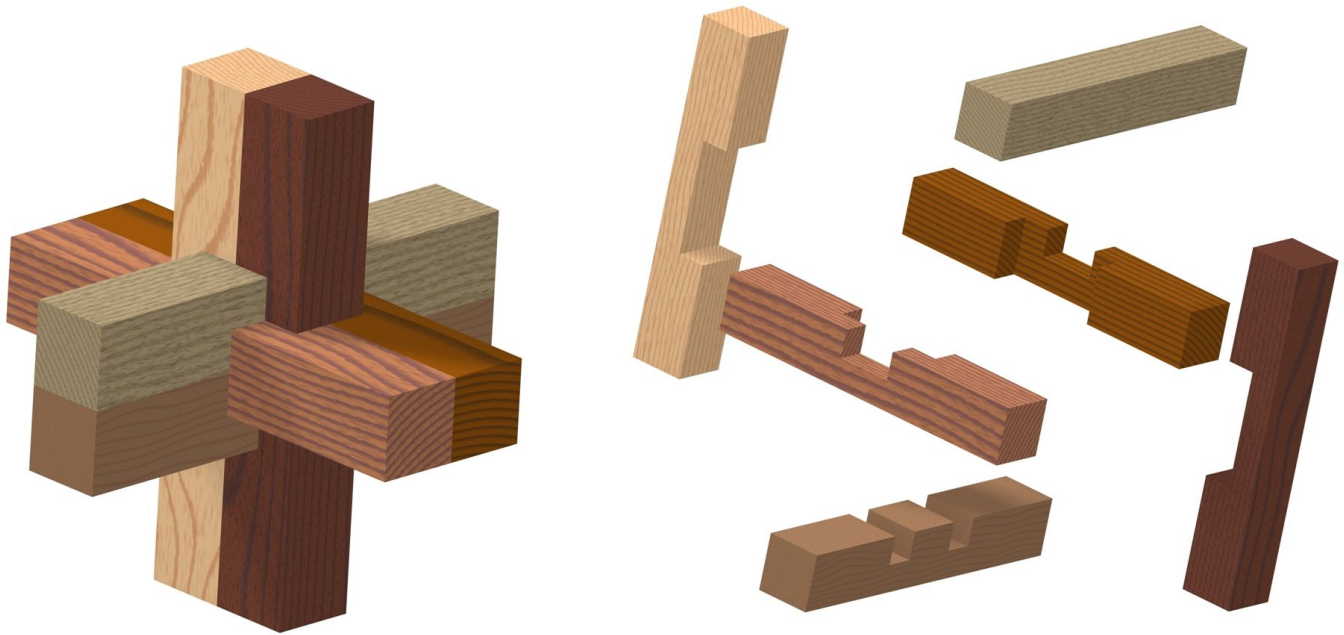

## Parts List

Item Number	Title	Material	Quantity
1	Part 1	Wood	2
2	Part 2	Wood	2
3	Part 3	Wood	1
4	Part 4	Wood	1

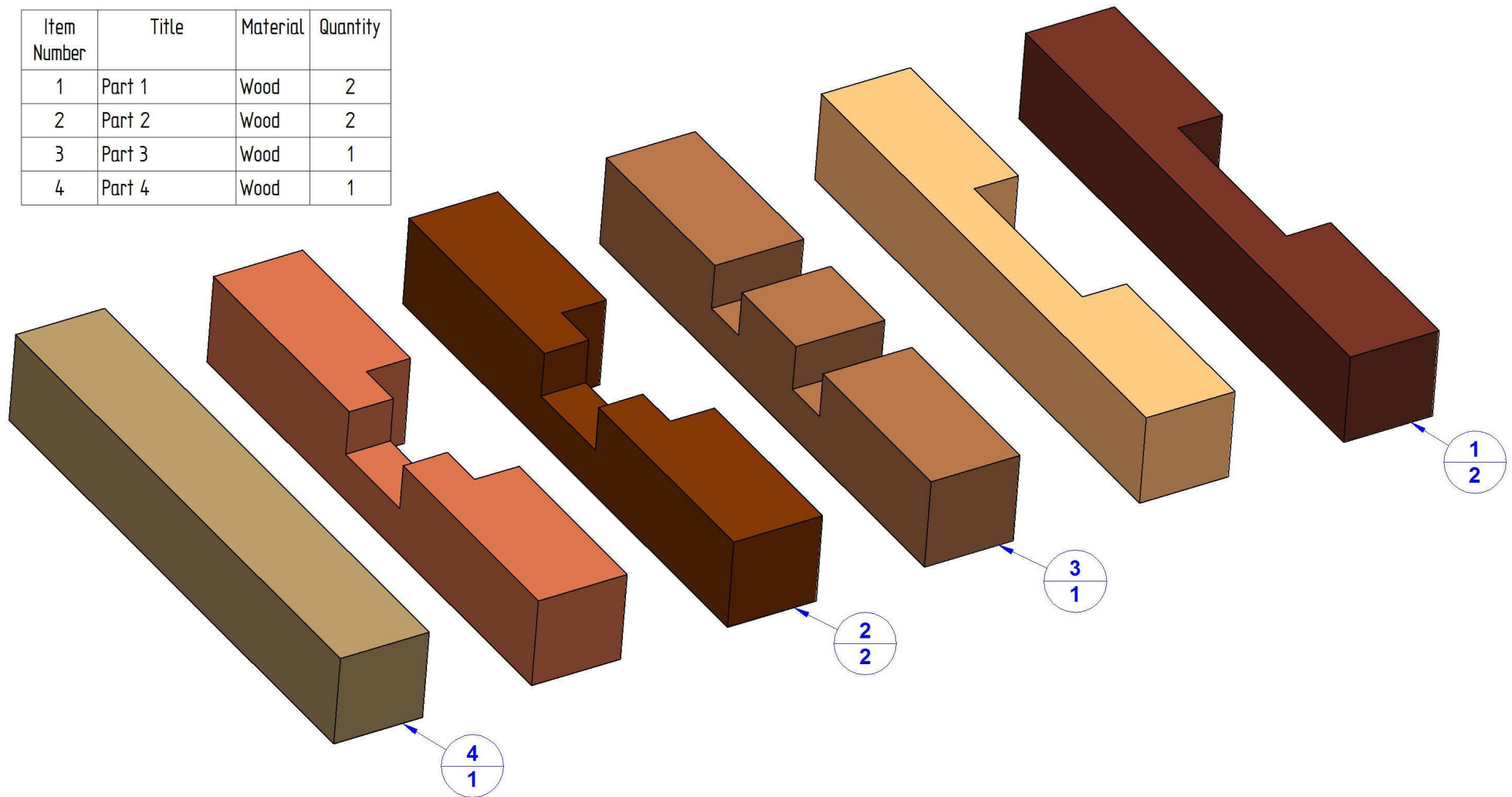

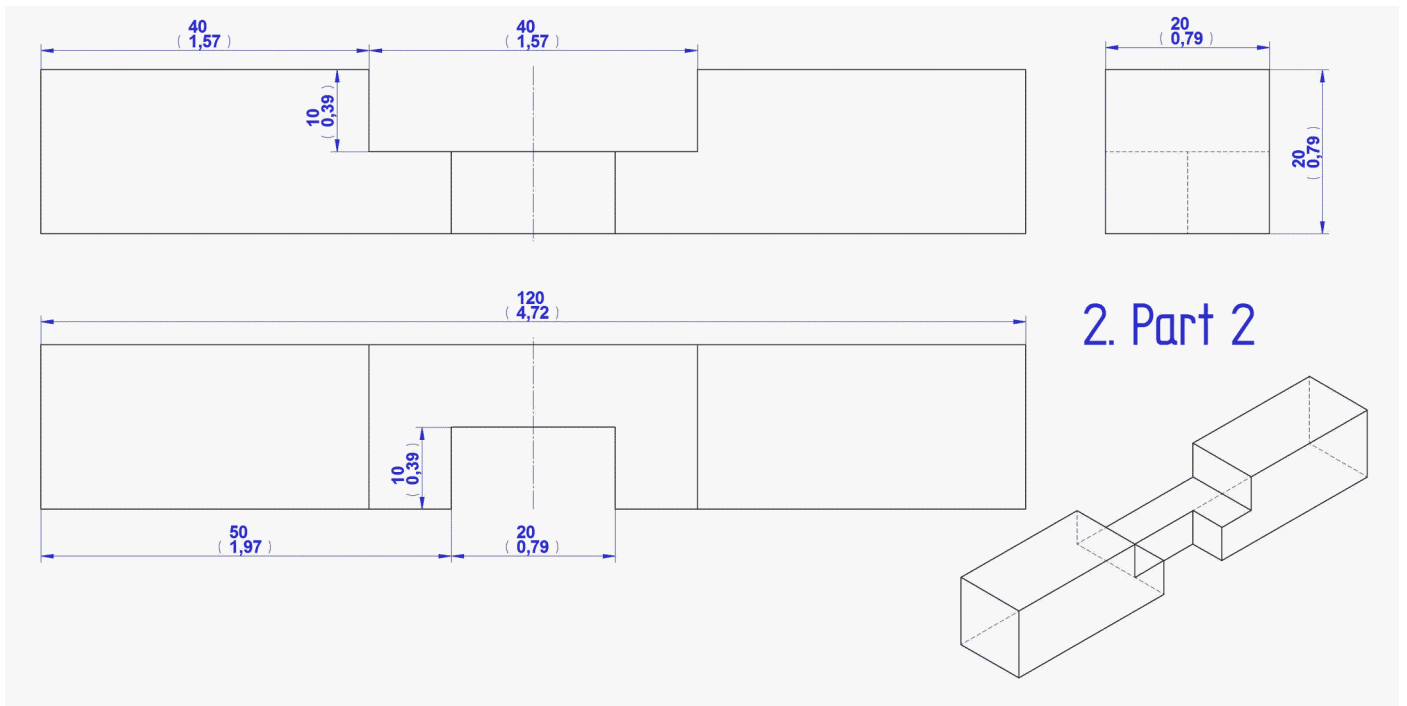
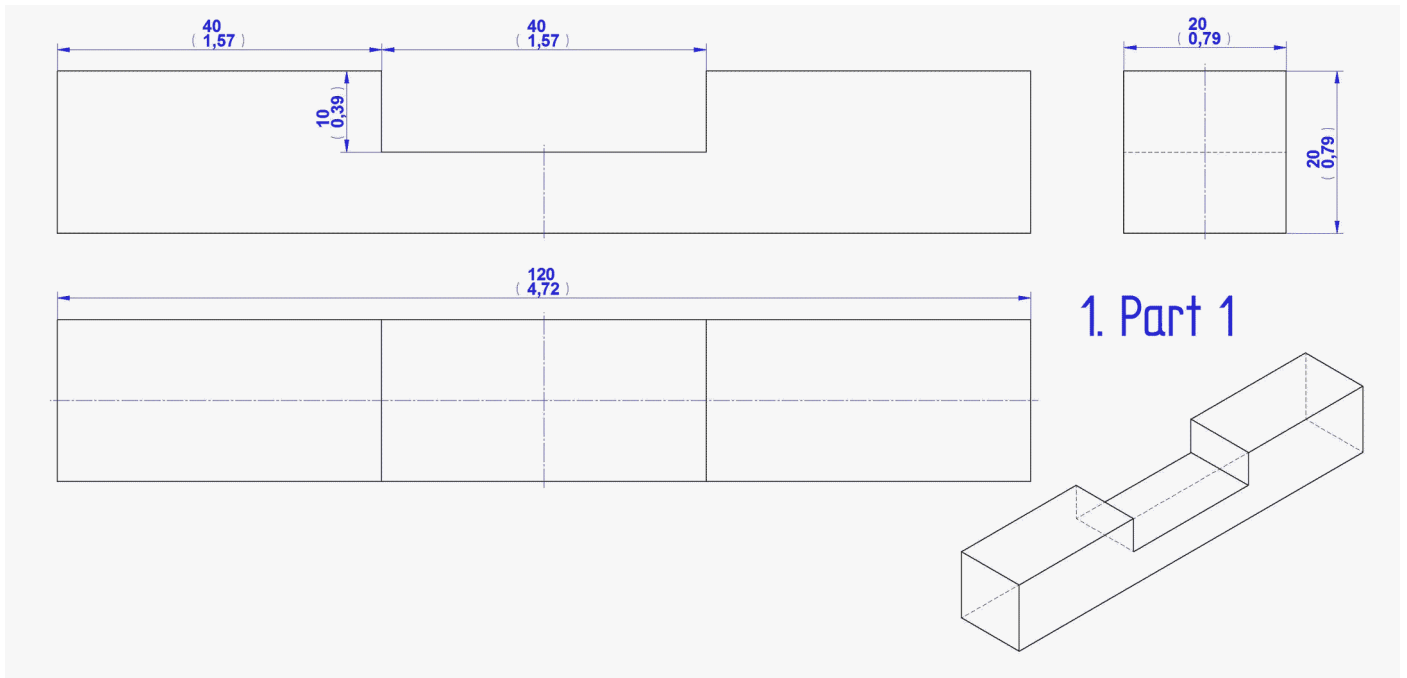

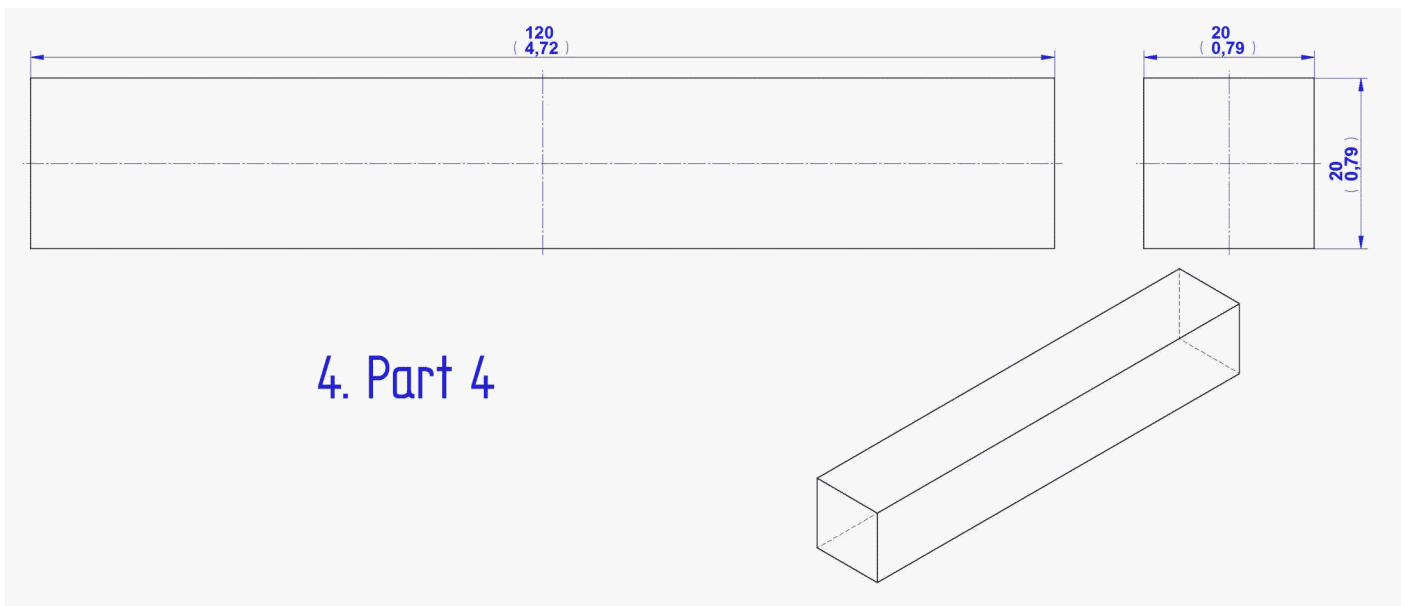
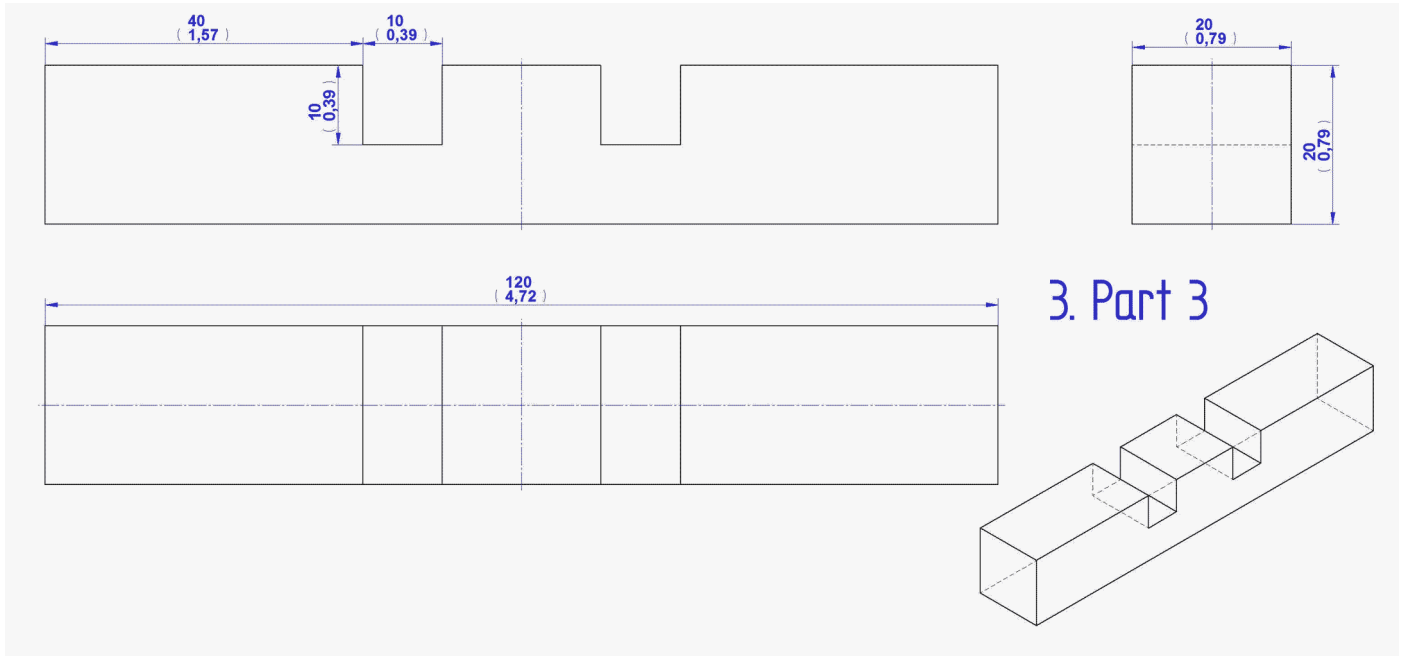

## Solution

### Step 1

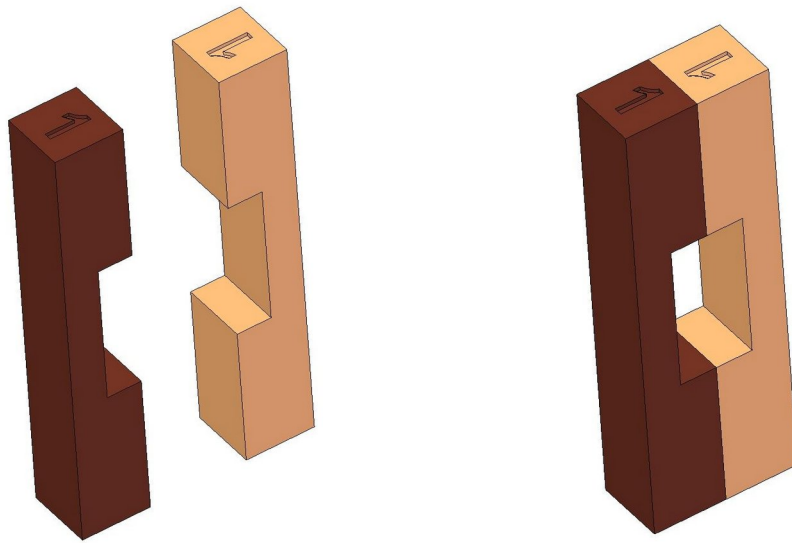

### Step 2

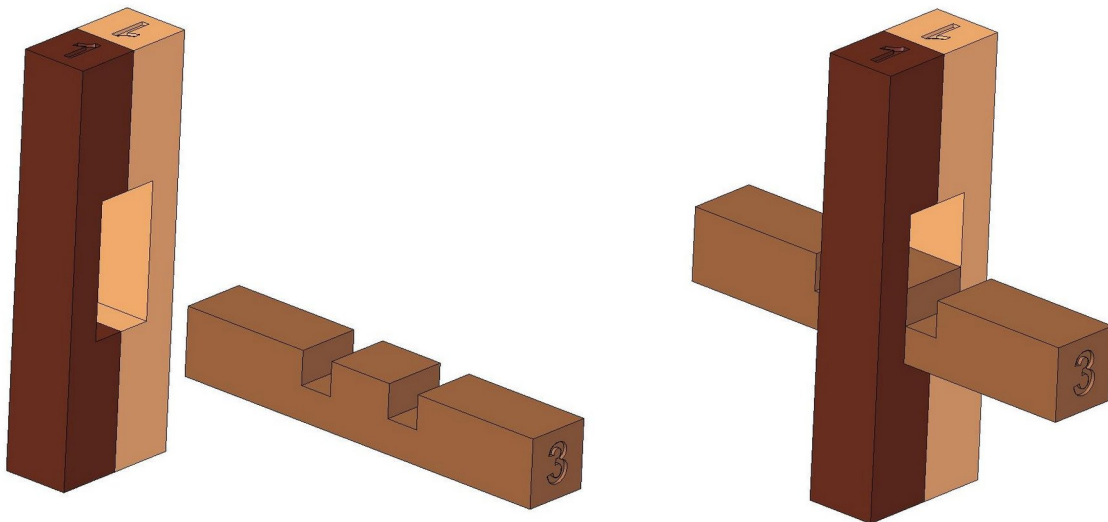

### Step 3

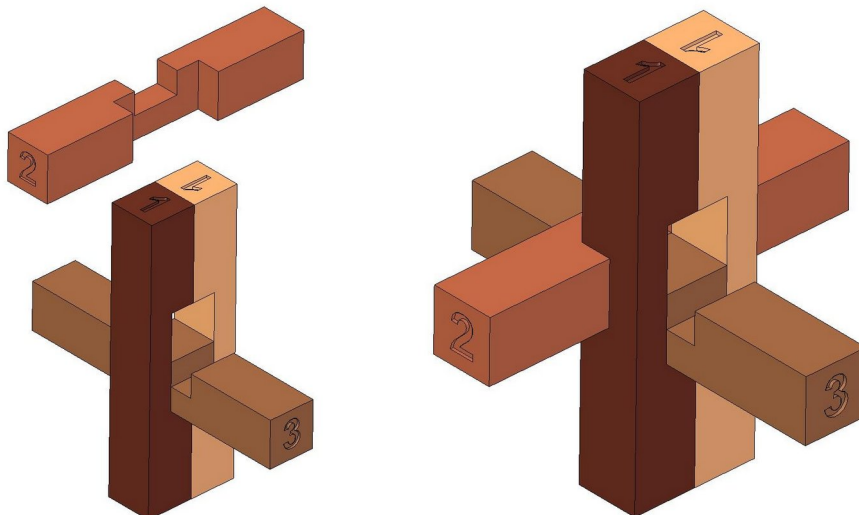

**Step 4**

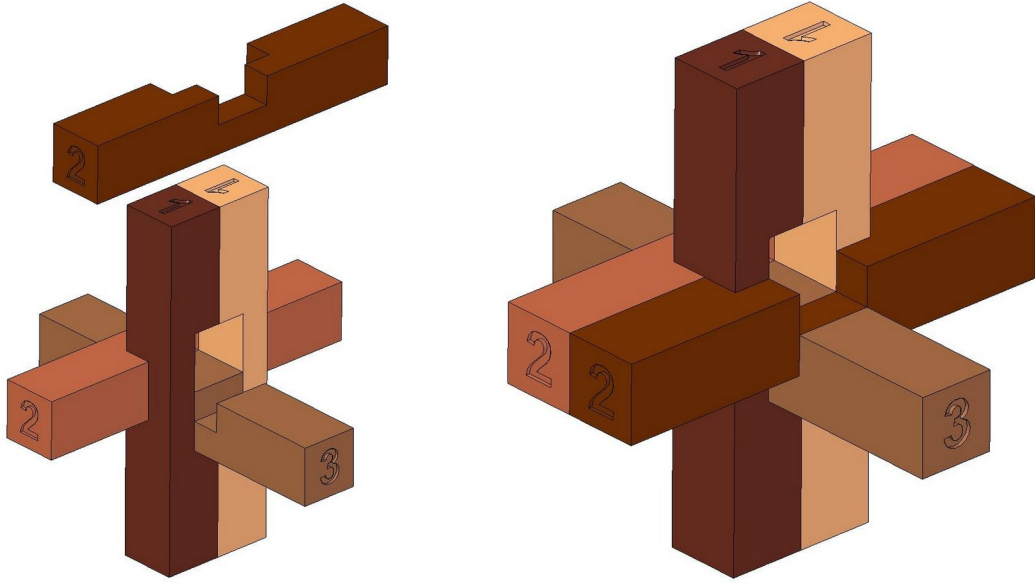

**Step 5**

